

# ASSEMBLY INSTRUCTION FOR MOPF-KD45-27888-BW-75"

**Note:**  
 ■ Read instructions carefully.  
 ■ Carefully identify each component especially those that are similar.  
 ■ Separate and identify each component from the hardware pack and rest each one in its proper location before fastening.  
 ■ Do not over tighten the screws or bolts when assembling.



2 Persons

## TOOL REQUIRED

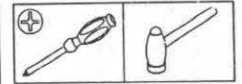

### Step 1

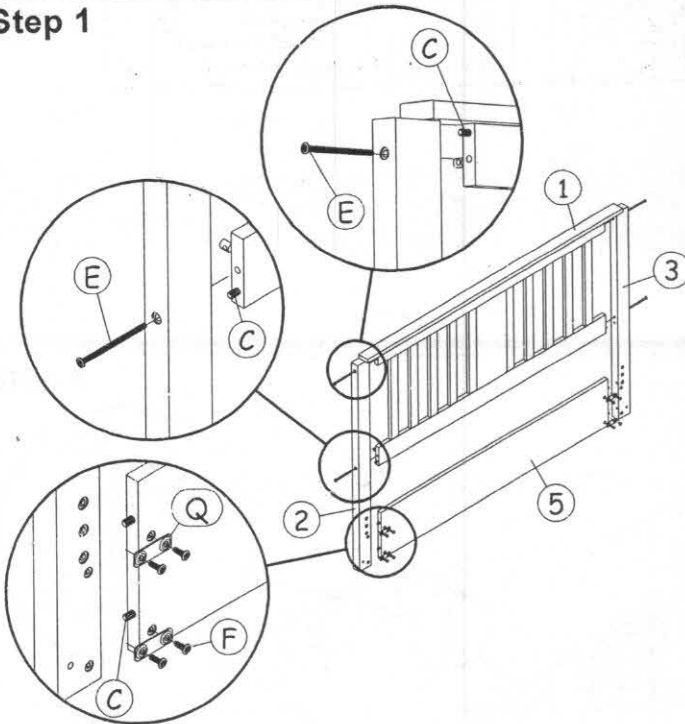

Fix all headboard component as shown

### Step 2

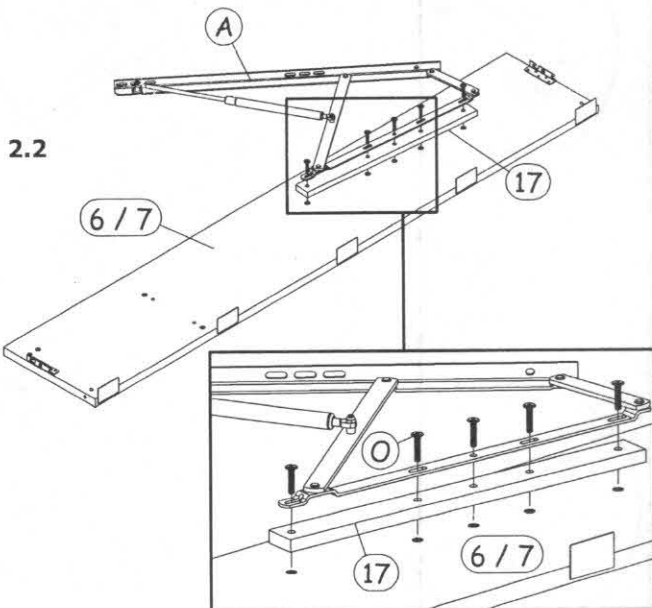
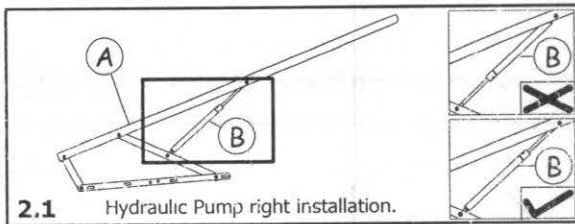

Firstly, fix the hydraulic pump to each hydraulic base as shown in diagram 2.1. Next, fix the left & right hydraulic spacer together with hydraulic base support to the both side rails using bolts 'O' as shown in diagram 2.2 and tighten all bolts.

### Step 3

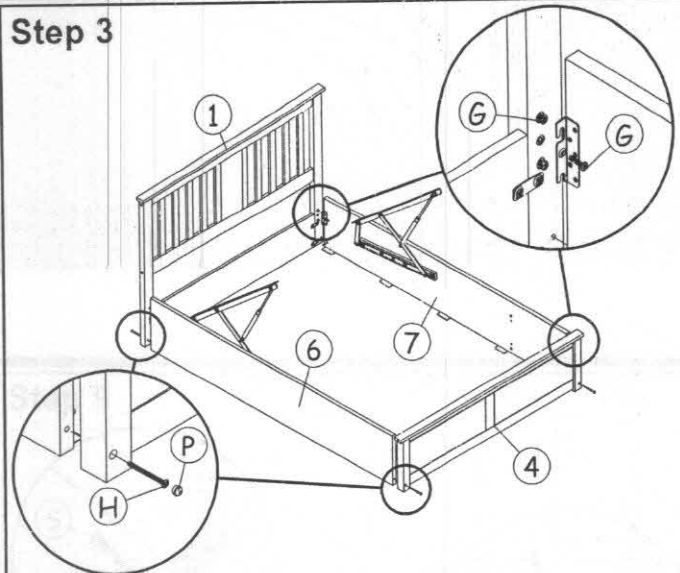

Fix side rails to the headboard and footboard with hardware as shown.

### Step 4

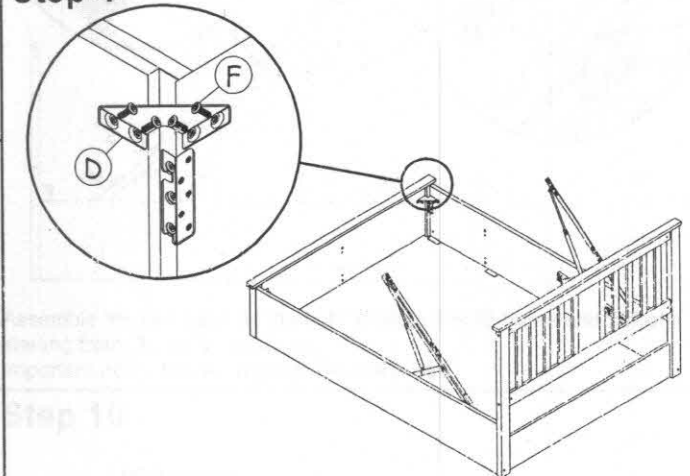

Fix metal corner block 'D' to the edge of footboard and side rails with bolts 'F' as shown.



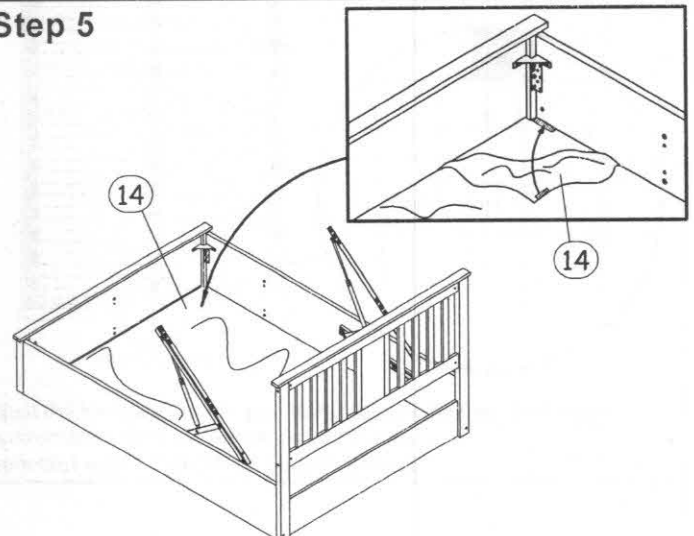













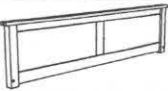



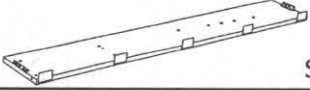

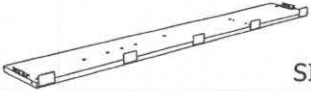







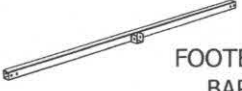
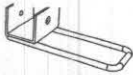





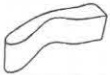

### Step 5



Attach Non-Woven Fabric '14' at the bottom as shown in diagram.

Please follow our assembly instruction procedure for easier assemble.

# PARTS & HARDWARE LIST FOR MOPF-KD45-27888-BW-75"

PART LIST				NO.	ITEM	QTY.
NO.	ITEM		QTY.			
1		HEADBOARD FRAME	1 PC	A	 HYDRAULIC BASE SUPPORT - L/R	2 PCS
2		WOOD POST (L)	1 PC	B	 HYDRAULIC PUMP	2 PCS
3		WOOD POST (R)	1 PC	C	 WOOD DOWEL 8 x 30	14 PCS
4		FOOTBOARD	1 PC	D	 CORNER BRACKET	2 PCS
5		BACK STORAGE PANEL	1 PC	E	 JCBC BOLT M6 x 100MM c/w BARREL NUT	4 PCS
6		SIDE RAIL (L)	1 PC	F	 JCBC BOLT M6 x 15MM	16 PCS
7		SIDE RAIL (R)	1 PC	G	 JCBC BOLT M6 x 20MM	12 PCS
8		LEFT SIDE METAL BAR	1 PC	H	 JCBC BOLT M6 x 70MM c/w BARREL NUT	4 PCS
9		RIGHT SIDE METAL BAR	1 PC	I	 FLAT WASHER	8 PCS
10		HEADBOARD END METAL BAR	1 PC	J	 WASHER BRACKET	4 PCS
11		FOOTBOARD END METAL BAR	1 PC	K	 BASE HANDLE	2 PCS
12		CENTER METAL BAR	1 PC	L	 JCBC BOLT M6 x 45MM	12 PCS
13		SLAT	26 PCS	M	 M8 x 45MM JCBB BOLT c/w NUT BRACKET, SPRING & FLAT WASHER	6 PCS
14		NON-WOVEN FABRIC SHEET	1 PC	N	 SINGLE END PLASTIC CAP	28 PCS
15		SUPPORT LEG	2 PCS	O	 JCBB BOLT M8 x 35MM	10 PCS
16		BELT HANDLE	1 PC	P	 WOOD BUTTON	2 PCS
17		HYDRAULIC ARM SUPPORT	2 PCS	Q	 BRACKET	4 PCS
18		BASE SUPPORT WOOD	3 PCS	R	 JCBC BOLT M6 x 60mm	6 PCS
				S	 JCBC BOLT M8 x 40mm (ASSEMBLED)	2 PCS
				T	 DOUBLE END PLASTIC CAP	14 PCS
				U	 ALLEN KEY - M6	1 PC
				V	 ALLEN KEY - M8	1 PC
				W	 M12.8 SPANAR	1 PC

\*CAUTION : KEEP ALL HARDWARE PARTS OUT OF REACH OF CHILDREN\*

Please follow our assembly instruction procedure for easier assemble.

---

## **" IMPORTANT NOTE "**

---

WHEN THE BED IS BUILT AND THE MATTRESS FRAME IS AT 45 DEGREE  
PLEASE PLACE THE MATTRESS ON THE BED.

PLEASE NOTE THAT THE WEIGHT OF THE MATTRESS IS REQUIRED TO  
HELP CLOSE THE BED.

TO LOWER THE SLEEPING PLATFORM STAND AT THE FOOT END OF THE  
BED AND PUSH SHARPLY  
DOWNWARDS USING BOTH HANDS.

