

STEP 2

Attach and secure **Wooden Slats** onto both **Side Rails** by using **(B)**, tighten it up by using a Crosshead Screw Driver.

ASSEMBLY INSTRUCTION

MODEL : WS 1604 CHARLESTON 3' BED (915 x 1905)MM

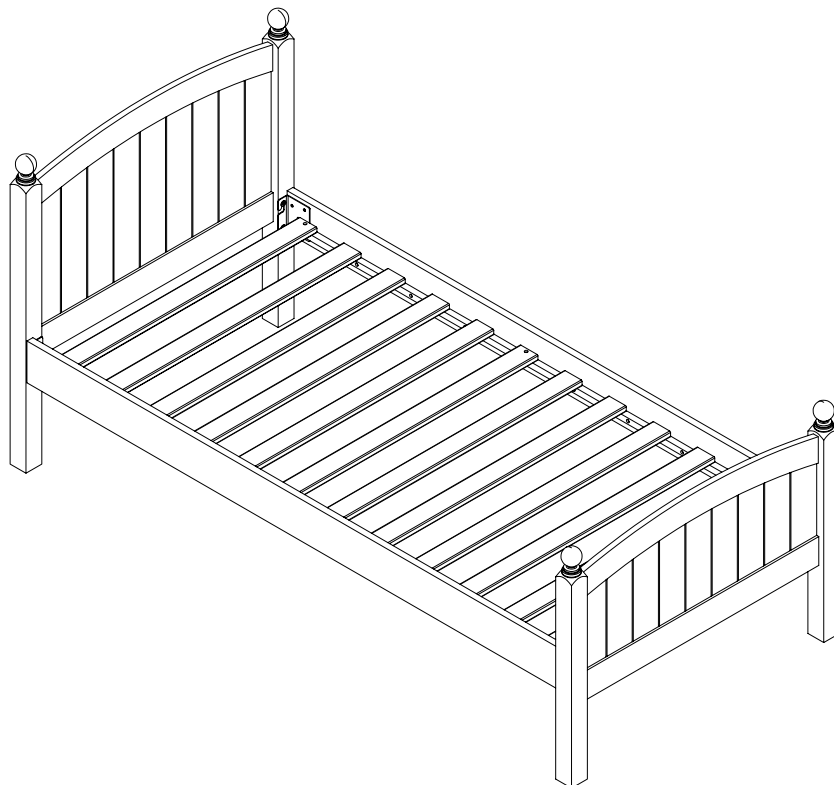

HARDWARE LIST

A  **8 PCS**
JCBB BOLT (M8 x 20MM)

B  **6 PCS**
CSK C/B SCREW (M4 x 32MM)

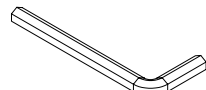
C  **1 PC**
ALLEN KEY (M5 x 60MM)

Tool Required : Crosshead Screw Driver

PARTS LIST

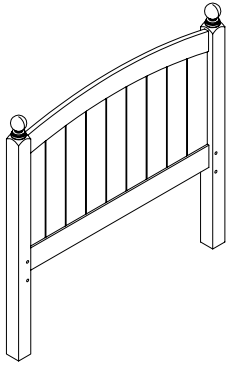

HEADBOARD
1 PC / SET
(CARTON 1 OF 2)

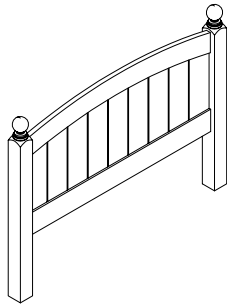

FOOTBOARD
1 PC / SET
(CARTON 1 OF 2)

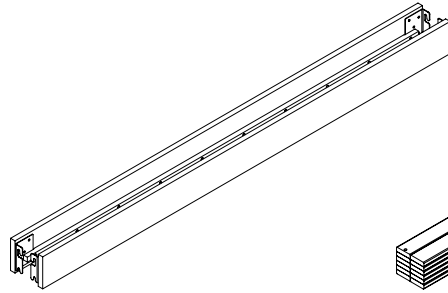

SIDE RAILS
2 PCS / SET
(CARTON 2 OF 2)

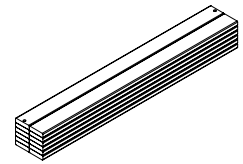

WOODEN SLATS
12 PCS / SET
(CARTON 1 OF 2)

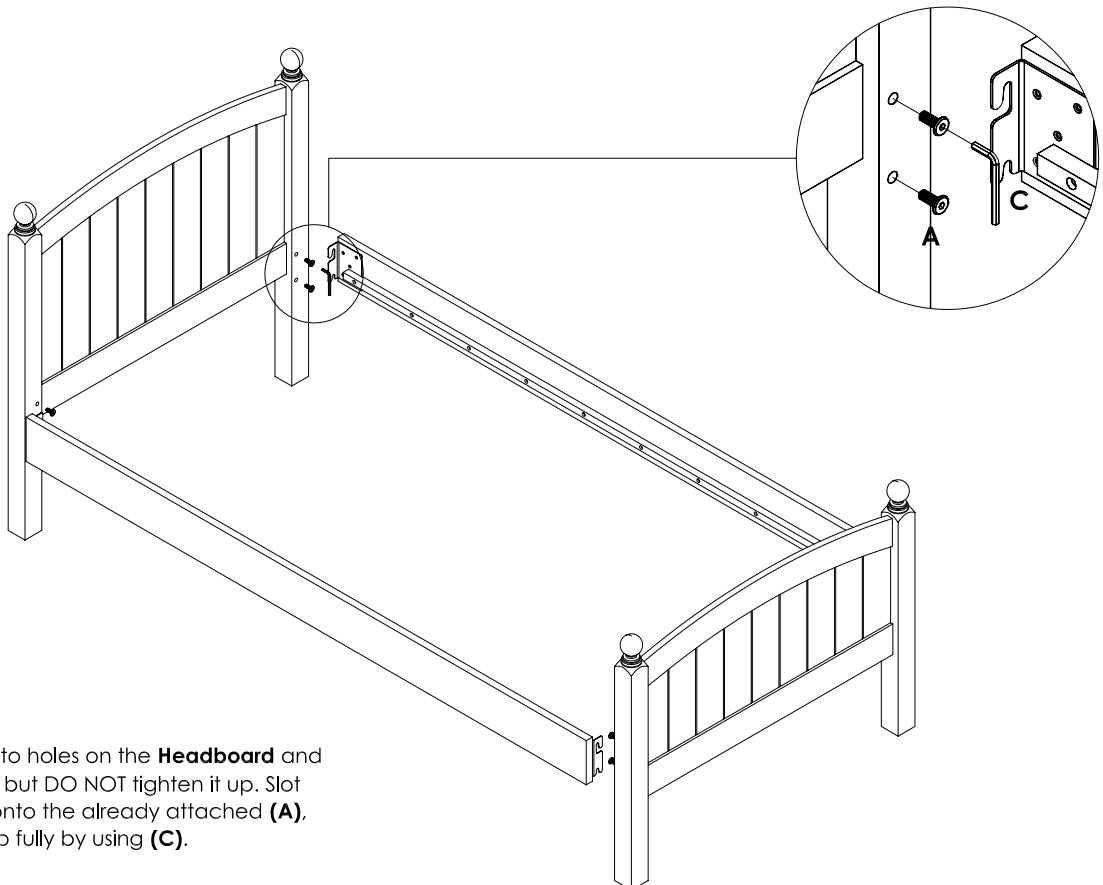

STEP 1

Insert **(A)** into holes on the **Headboard** and **Footboard**, but **DO NOT** tighten it up. Slot **Side Rails** onto the already attached **(A)**, tighten it up fully by using **(C)**.