





















ASSEMBLY INSTRUCTION

MODEL : CF 9380-B (46")

A		1 pc
B		1 pc
C		2 pcs
D		2 pcs
E		2 pcs
F		1 pc
G		2 pcs
H		26 pcs
I		13 pcs
J		26 pcs
K		1 pc
L		1 pc
M		2 pcs
N		10 pcs
O		10 pcs
P		8 pcs
Q		2 pcs
R		6 pcs
S		4 pcs
T		2 pcs

Step 1 : Zip the black non-woven fabric after take out the headboard legs.

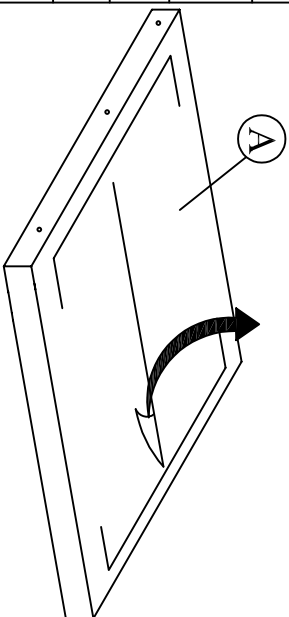

Step 2 : Install the headboard legs (D) / footboard legs (E) to footboard (B) and headboard (A). Tighten the legs.

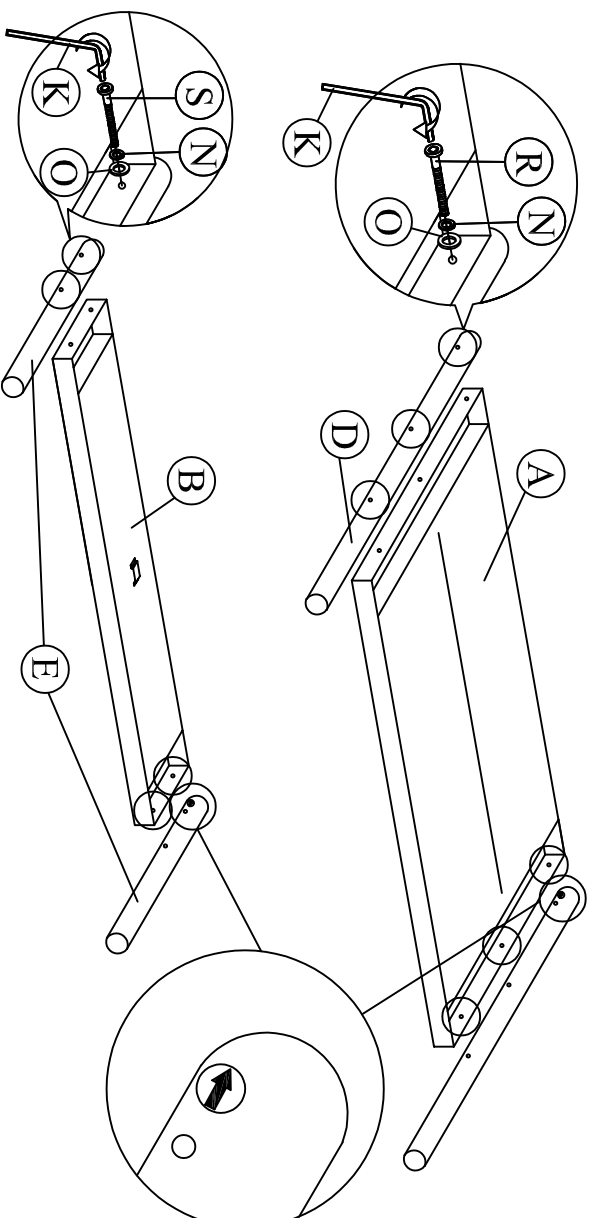

Step 3 : Attach side rail (C) to footboard (B) and headboard (A) by pushing the bracket down to fit it.

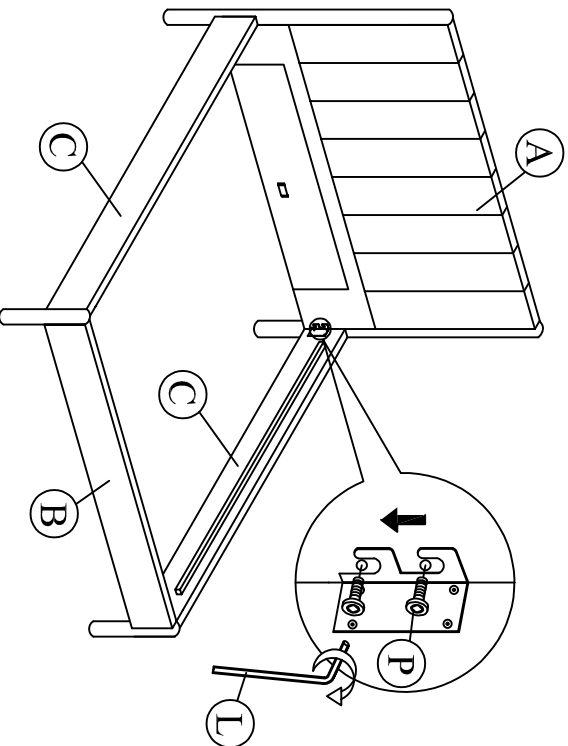

Step 4: Attach the support legs (G) to the center rail (F) of the bed as shown.

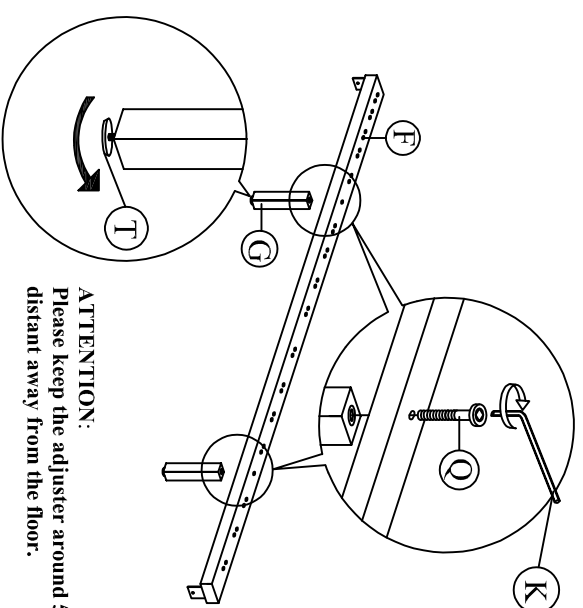

ATTENTION:
Please keep the adjuster around 5 to 8 mm distant away from the floor.

Step 5 : Slide the center rail (F) to the headboard (A) and footboard (B). Tighten screws (M) using screw driver (not included) to the headboard (A) and footboard (B).

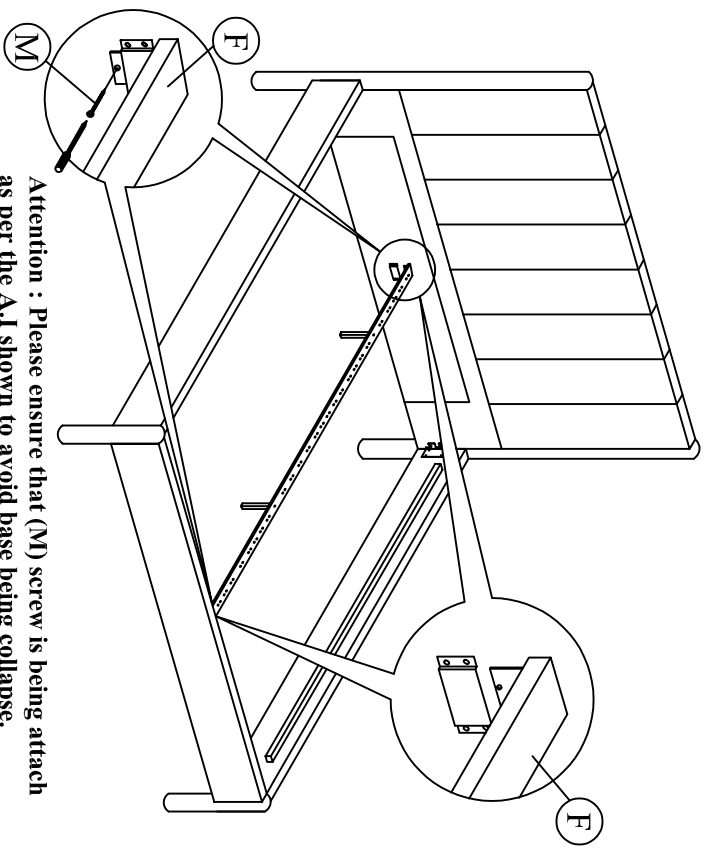

Attention : Please ensure that (M) screw is being attach as per the A.I shown to avoid base being collapse.

Step 6 : Tighten all the 4 corner, follow by assembly of the slat holders with L.VL slats as shown.

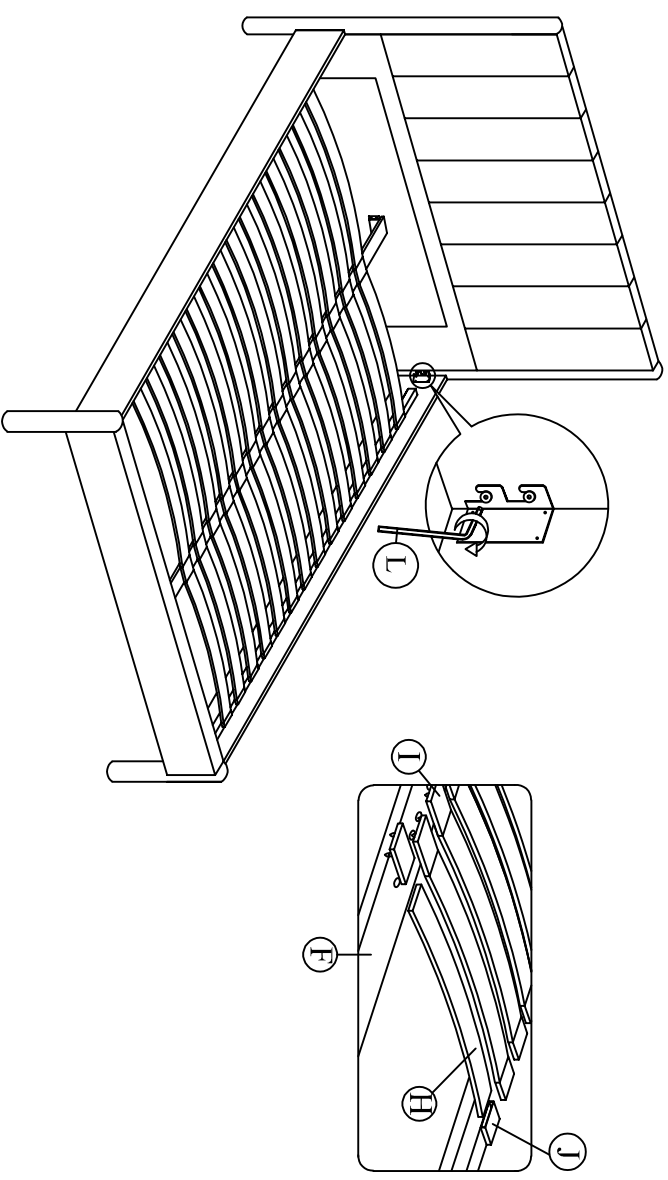

Important Information

Please note that the recommended process for adjusting centre legs when assembling your bed.

Before placing the mattress on the base, please ensure that the **SUPPORT LEGS ARE NOT QUITE TOUCHING THE FLOOR**. When the bed is then in use the support legs will sit firmly on the solid surface.

PLEASE ENSURE THAT THE LEGS ARE VERTICAL.

DUE TO THE NATURE OF LAMINATE / WOODEN FLOORING WE RECOMMEND THAT YOU PLACE A SMALL PIECE OF NON SLIP MATERIAL UNDER THE LEGS WHICH WILL GIVE YOU THE FLEXIBILITY THE ADJUSTERS NEED.

When moving the bed it is essential that it is **LIFTED** into the new position. **NEVER DRAG** the bed as this will move the legs from the vertical position thus weakening the support of the centre rail.

Adhering to the recommended process should ensure that your bed gives you years of trouble free service.