







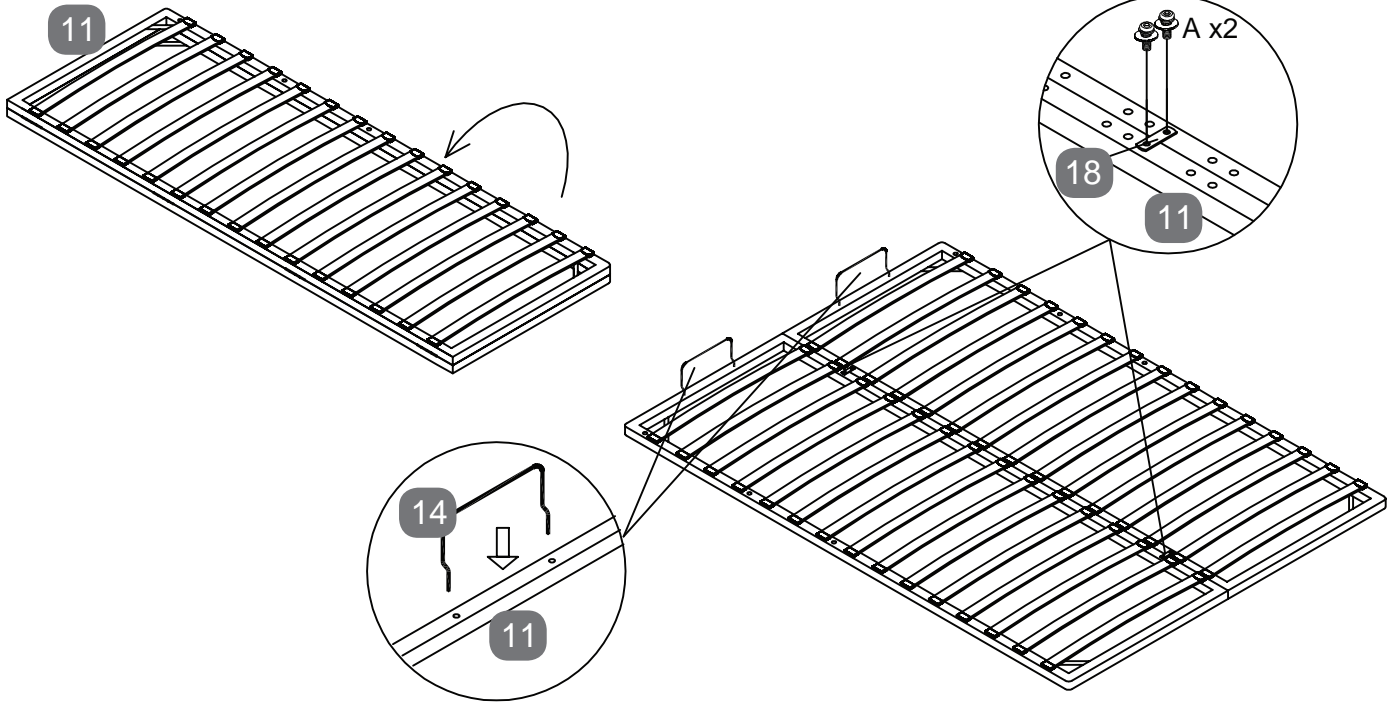

Stage
8

A  x4 M  x1



Stage
9

C  x6 G  x6 H  x6 I  x6

M  x1 P  x1

